

European Style Residential Pasta Sheeter With 5.75" Roller Width

ITEM: 13234
MODEL: PM-IT-0146

Easy and efficient

With its electric motor, this pasta sheeter quickly makes sheets of pasta in six different thickness and cuts it into two types of pasta: tagliatelle and fettuccine. Ideal for home use.

FEATURES:

- Cuts pasta into varying thickness using adjustment knob
- Electric motor makes pasta making process quick
- Includes safety guard



1-833-487-3686

www.trentoequipment.com

sales@trentoequipment.com

Follow us on social media
@trentoequipment

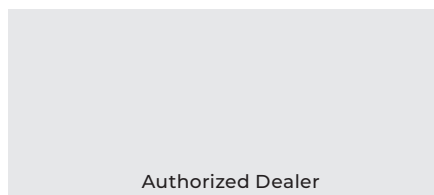

Authorized Dealer

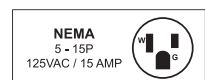

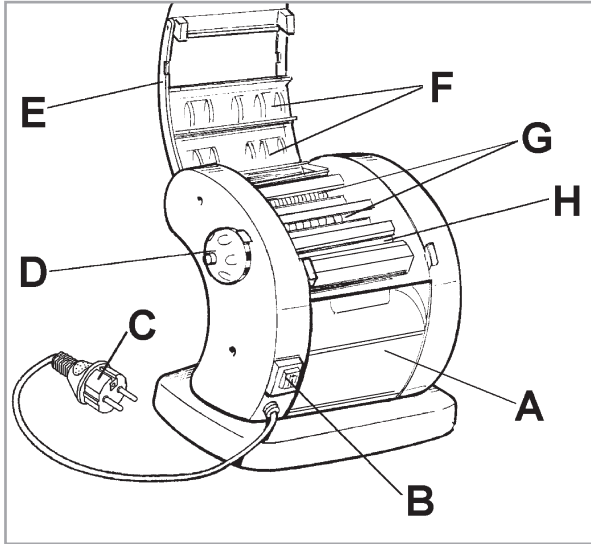

PARTS AND DESCRIPTIONS



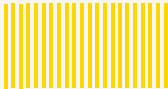

- A. Machine Body
- B. Main Switch
- C. Power
- D. Adjustment Knob
- E. Safety Guard
- F. Mobile Guards
- G. Cutter Rollers
- H. Stretching Rollers

Optional Cutters*

- 

Capelli D'Angelo
1.5 mm
Item 16991
- 

Spaghetti
Ø 2 mm
Item 16988
- 

Trenette
4 mm
Item 16989
- 

Lasagnette
12 mm
Item 16990

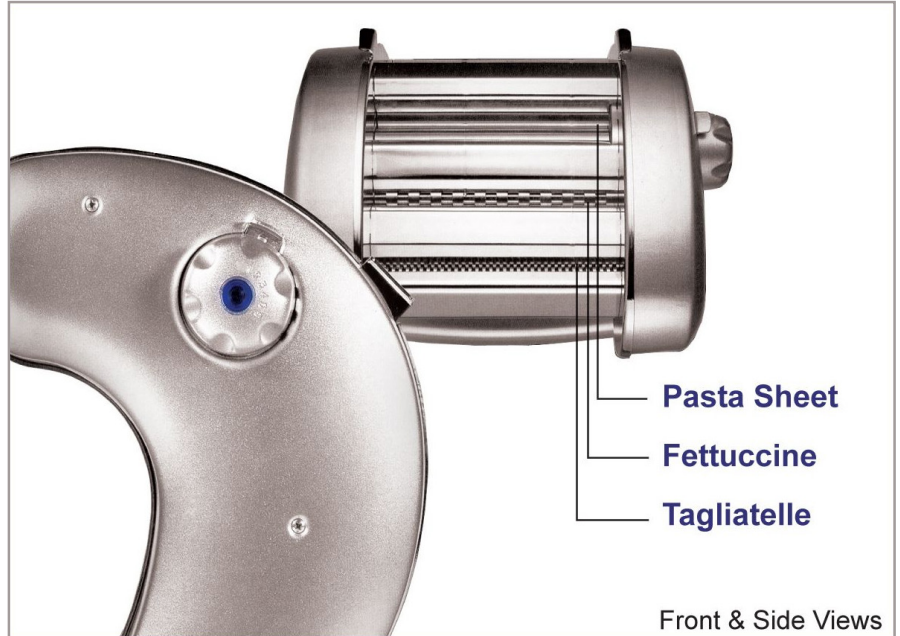

Front & Side Views

Technical Specification	
Item	13234
Model	PM-IT-0146
Roller Width	5.75" (146 mm)
Maximum Roller Opening	0.07" (1.9 mm)
Roller Revolution Speed	36 - 48
Nominal Power	85 W
Electrical	120V / 60Hz / 1Ph
Net Weight	13 lb. (6 kg.)
Net Dimensions (WDH)	10.5" x 8.25" x 10.5" (266 x 209 x 266 mm)
Gross Weight	14 lb. (6.3 kg.)
Gross Dimensions (WDH)	10" x 12" x 12" (254 x 304 x 304 mm)
Plug Type	NEMA 5 - 15P

*Size not exactly as shown. Other types of cutters also available - **CALL for more information**